

# MASTER VIEW KVM SWITCH



## USER MANUAL

---

**ACS-1208A**

**ACS-1216A**

2003-06-20

**Note:** This equipment has been tested and found to comply with the limits for a Class B digital device, pursuant to Part 15 of the FCC Rules. These limits are designed to provide reasonable protection against harmful interference in a residential installation. This equipment generates, uses and can radiate radio frequency energy, and if not installed and used in accordance with the instruction manual, may cause interference to radio communications. However, there is no guarantee that interference will not occur in a particular installation. If this equipment does cause harmful interference to radio or television reception, which can be determined by turning the equipment off and on, the user is encouraged to try to correct the interference by one or more of the following measures:

- ◆ Reorient or relocate the receiving antenna;
- ◆ Increase the separation between the equipment and receiver;
- ◆ Connect the equipment into an outlet on a circuit different from that which the receiver is connected;
- ◆ Consult the dealer or an experienced radio/television technician for help.



---

## Packing List

---

The complete ACS-1208A / ACS-1216A package consists of:

- ◆ 1 ACS-1208A or ACS-1216A KVM Switch
- ◆ 2 Custom KVM Cable Sets (2L-5202P)
- ◆ 1 Firmware Upgrade Cable
- ◆ 1 Power Adapter
- ◆ 1 Rack Mounting Kit
- ◆ 1 User Manual

Check to make sure that all the components are present and that nothing got damaged in shipping. If you encounter a problem, contact your dealer.

Read this manual thoroughly and follow the installation and operation procedures carefully to prevent any damage to the unit, and/or any of the devices connected to it.

© Copyright 2003 ATEN® International Co., Ltd.  
Manual Part No. PAPE-0211-1AT  
Printed in Taiwan 06/2003

All brand names and trademarks are the registered property of their respective owners.

---

# Table of Contents

---

## 1. Introduction

Overview . . . . .	1-1
Features . . . . .	1-3
Hardware Requirements . . . . .	1-4
Console . . . . .	1-4
Computers . . . . .	1-4
Cables . . . . .	1-5
ACS-1208A Front View . . . . .	1-6
ACS-1216A Front View . . . . .	1-8
ACS-1208A / ACS-1216A Rear View . . . . .	1-10

## 2. Installation

Before you Begin . . . . .	2-1
Single Stage Installation . . . . .	2-1
Daisy Chaining . . . . .	2-2
Hot Plugging . . . . .	2-5
Port ID Numbering . . . . .	2-6
Powering Off and Restarting . . . . .	2-6

## 3. Hotkey Operation

Hotkey Port Access . . . . .	3-1
Invoking Hotkey Mode . . . . .	3-1
Selecting the Active Port . . . . .	3-2
Auto Scanning . . . . .	3-3
Skip Mode . . . . .	3-5
Hotkey Beeper Control . . . . .	3-6
Hotkey Summary Table . . . . .	3-6

## 4. OSD Operation

OSD Operation . . . . .	4-1
OSD Overview . . . . .	4-1
OSD Navigation . . . . .	4-3
OSD Main Screen Headings . . . . .	4-3
OSD Functions . . . . .	4-4

## 5. The Firmware Upgrade Utility

Introduction . . . . .	5-1
Purpose . . . . .	5-1
Before You Begin . . . . .	5-2
Performing the Upgrade . . . . .	5-3
Starting the Upgrade . . . . .	5-3
Upgrade Succeeded . . . . .	5-6
Upgrade Failed . . . . .	5-7
Firmware Upgrade Recovery . . . . .	5-8

## Appendix

ACS-1208A /ACS-1216A - Connection Tables . . . . .	A-1
ACS-1208A . . . . .	A-1
ACS-1216A . . . . .	A-2
OSD Factory Default Settings . . . . .	A-2
Clear Login Information . . . . .	A-3
Specifications . . . . .	A-4
Rack Mounting . . . . .	A-5
Troubleshooting . . . . .	A-6
Limited Warranty . . . . .	A-6

---

## About This Manual

---

This User Manual is provided to help you get the most from your ACS-1208A / ACS-1216A system. It covers all aspects of installation, configuration and operation. An overview of the information found in the manual is provided below.

---

### Overview

**Chapter 1, Introduction**, introduces you to the ACS-1208A / ACS-1216A System. Its purpose, features and benefits are presented, and its front and back panel components are described.

**Chapter 2, Installation**, explains how to set up your installation — from a basic single stage hookup to a complete 32 switch daisy chained operation.

**Chapter 3, Hotkey Operation**, details all of the concepts and procedures involved in the Hotkey operation of your ACS-1208A / ACS-1216A installation.

**Chapter 4, OSD Operation**, provides a complete description of the ACS-1208A / ACS-1216A's OSD (On Screen Display), and how to work with it.

**Chapter 5, The Firmware Upgrade Utility**, explains how to use this utility to upgrade the ACS-1208A / ACS-1216A's firmware with the latest available versions.

**An Appendix** at the end of the manual provides specifications and other technical information regarding the ACS-1208A / ACS-1216A.

**An Index** follows the Appendix for convenient reference to the manual's information.

---

**Conventions**

The following typographical conventions are used throughout this manual:

- ◆ Bullet lists provide information, but not procedural steps.
- ◆ Numbered lists represent procedures with sequential steps.
- ◆ An indented typeface like the one below:

*Key information in*

indicates words and characters you key in. Unless otherwise mentioned, you can use either upper or lower case.

- ◆ The names of the keys you should press are placed inside of square brackets, and appear just as they do on the keyboard (for example, [Alt], [Enter], [Esc]).

Don't type the brackets or anything that appears inside of them, just press the key. For example, if a procedure tells you to type:

*Install* [Enter]

You should type the word *Install*, then press the Enter key.

- ◆ If you need to hold down one key and, while you are holding it down, press another key, the keys appear in square brackets with a dash between them. For example, [Ctrl-Alt-Del] means to hold down the Ctrl and Alt keys and, while they are being held down, press the Del key and then release all the keys together.
- ◆ If you are asked to *Choose* or *Select* an item listed on a menu, Click it with the mouse. An alternate shortcut method is to press the appropriate accelerator key combination indicated on the menu.

**Notes:**

---



## Chapter 1.

# Introduction

This chapter introduces you to the ACS-1208A / ACS-1216A KVM Switch. Its purpose, features and benefits are presented, and its front and back panel components are described.

---

## Overview

---

The Master View ACS-1208A and ACS-1216A KVM Switches are control units that allow access to multiple computers from a single console (keyboard, mouse, and monitor). Before the development of the Master View, the only way to control multiple computer configurations from a single console was through a complex and costly network system. Now, with the ACS-1208A / ACS-1216A, you can easily access multiple computers in a cost effective manner.

A single Master View can control up to eight (ACS-1208A) or 16 (ACS-1216A) computers. As many as 31 additional switches can be added in a daisy chain configuration, allowing up to 512 computers to be controlled from a single keyboard-monitor-mouse console.

An auto-sensing function recognizes the position of each station (switch) on the chain, eliminating the need to manually set the position with DIP switches. A seven segment front panel LED displays each Station's position for easy identification.

The ACS-1208A / ACS-1216A improves on previous models and similar switches commonly found on the market with a custom ASIC (patent pending) for increased reliability and enhanced performance, and high density 15 pin CPU port connectors instead of the usual 25 pin connectors. This space-saving innovation allows a full, 16 port switch, to be installed in a 1U system rack.

Your ACS-1208A / ACS-1216A investment is protected by an included *Firmware Upgrade Utility*. You can stay current with the latest improvements in functionality by downloading the latest firmware files from our website and using the utility to quickly and conveniently perform the upgrade.

Setup is fast and easy; plugging cables into their respective ports is all that is entailed. The ACS-1208A / ACS-1216A intercepts keyboard input directly, which means that there is no software to configure, no complex installation routines, and no need to be concerned with incompatibility problems.

Access to any computer on the installation is easily accomplished either by entering *Hotkey* combinations from the keyboard, or by means of a powerful menu driven OSD (On Screen Display) system. A convenient *Auto Scan* feature also permits automatic scanning and monitoring of the activities of all computers running on the installation one by one.

There is no better way to save time and money than with a Master View ACS-1208A / ACS-1216A installation. By allowing a single console to manage all of the attached computers, an ACS-1208A / ACS-1216A installation: (1) eliminates the expense of having to purchase a separate keyboard, monitor, and mouse for each computer; (2) saves all the space those extra components would take up; (3) saves on energy costs; and (4) eliminates the inconvenience and wasted effort involved in constantly moving from one computer to another.

---

## Features

---

- ◆ A single console controls up to 8 (ACS-1208A) or 16 (ACS-1216A) computers
  - ◆ Daisy chain up to 31 additional units - control up to 512 computers from a single console
  - ◆ No software required - convenient computer selection via *Hotkeys* and intuitive OSD menus
  - ◆ Auto Scan feature for monitoring user-selected computers
  - ◆ Hot Pluggable - add or remove computers without having to power down the switch
  - ◆ Custom ASIC (patent pending) for increased reliability and enhanced performance
  - ◆ Auto-sensing of station's position on daisy chained installations - no need for manual DIP Switch setting - front panel LED indicates station's position
  - ◆ Port names automatically reconfigured when station sequence is changed
  - ◆ Two level password security - only authorized users view and control the computers - up to four Users plus an Administrator - separate profiles for each
  - ◆ Two level logout - manual and timed
  - ◆ PS/2 keyboard and mouse emulation - computers boot even when the console focus is elsewhere
  - ◆ Supports\* PS/2 compatible mice, Microsoft Intellimouse Explorer, Logitech FirstMouse+
  - ◆ Superior video quality - supports resolutions of up to 1920 x 1440
  - ◆ Upgradable firmware
  - ◆ Rack mountable in 19" system rack (1U)
- \* PS/2 compatible mouse support is for 3 button wheel mice. The Logitech Mouse Ware program's *Change Device* procedure does not work on Microsoft NT computers.

---

## Hardware Requirements

---

---

### Console

- ◆ A VGA, SVGA, or Multisync monitor capable of the highest resolution that you will be using on any computer in the installation.
- ◆ A PS/2 style mouse
- ◆ A PS/2 style keyboard

---

### Computers

The following equipment must be installed on each computer:

- ◆ A VGA, SVGA or Multisync card.
- ◆ A 6-pin mini-DIN (PS/2 style) mouse port.\*
- ◆ Either a 6-pin mini-DIN (PS/2 Style) keyboard port with +5V DC on pin 4 and Ground on pin 3, or a 5-pin DIN (AT Style) keyboard port with +5V DC on pin 5 and ground on pin 4.\*

\* See the note under *Cables* in the next section.

**Cables** Substandard cables may damage the connected devices or degrade overall performance. For optimum signal integrity and to simplify the layout, we strongly recommend that you use the high quality CS Custom Cable sets described below:

Function	CS Part Number
KVM Switch to KVM Switch (Daisy Chaining)	2L-1700 - 0.6 m 2L-1701 - 1.8 m
KVM Switch to Computer	2L-5201P - 1.2 m 2L-5202P - 1.8 m 2L-5203P - 3.0 m



2L-1700 / 2L-1701



2L-5201P / 5202P / 5203P

- Note:**
1. The ACS-1208A / ACS-1216A does not support serial mice. You cannot use Serial-to-PS/2 adapters with the cables.
  2. If your computer uses an AT style keyboard socket you will need to purchase a PS/2-to-AT keyboard adapter (Part No. 2A-106, or any standard keyboard adapter), in order to plug the cable into the computer's keyboard port.

## ACS-1208A Front View

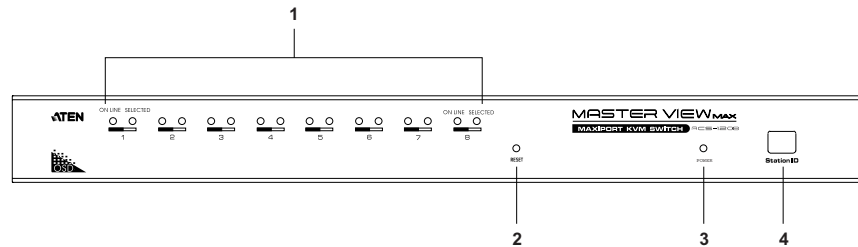

### 1. Port LEDs

The Port LEDs provide status information about their corresponding CPU Ports. There is one pair of LEDs for each Port. The one on the left is the *On Line* LED; the one on the right is the *Selected Port* LED:

- ◆ An *On Line* LED lights ORANGE to indicate that the computer attached to its corresponding port is up and running.
- ◆ A *Selected* LED lights GREEN to indicate that the computer attached to its corresponding port is the one that has the KVM focus. The LED is steady under normal conditions, but flashes when its port is accessed under *Auto Scan Mode* (see p. 4-14).
- ◆ When the ACS-1208A is first powered on, the *On Line* and *Selected* LEDs blink in sequence as the Switch performs a self-test.

### 2. Reset Switch

Pressing this switch in performs a system reset. The switch is recessed and must be pushed with a thin object - such as the end of a paper clip, or a ballpoint pen.

### **3. Power LED**

The Power LED lights to indicate that the ACS-1208A is powered up and ready to operate.

### **4. Station ID LED**

The ACS-1208A's Station ID is displayed here. If this is a Single Station installation (see p. 2-1), or the First Station on a Daisy Chained installation (see p. 2-2), the ACS-1208A has a Station ID of **01**.

On a Daisy Chained installation, the ACS-1208A auto-senses its position and displays the Station ID that corresponds to its place in the chain. (see *Port ID Numbering*, p. 2-6 for details).

---

## ACS-1216A Front View

---

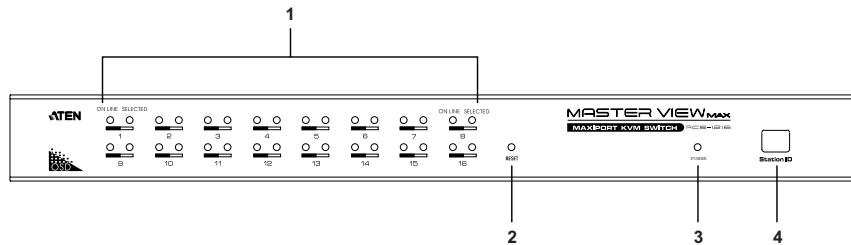

### 1. Port LEDs

The Port LEDs provide status information about their corresponding CPU Ports. There is one pair of LEDs for each Port. The one on the left is the *On Line* LED; the one on the right is the *Selected Port* LED:

- ◆ An *On Line* LED lights ORANGE to indicate that the computer attached to its corresponding port is up and running.
- ◆ A *Selected* LED lights GREEN to indicate that the computer attached to its corresponding port is the one that has the KVM focus. The LED is steady under normal conditions, but flashes when its port is accessed under *Auto Scan Mode* (see p. 4-14).
- ◆ When the ACS-1216A is first powered on, the *On Line* and *Selected* LEDs blink in sequence as the Switch performs a self-test.

### 2. Reset Switch

Pressing this switch in performs a system reset. The switch is recessed and must be pushed with a thin object - such as the end of a paper clip, or a ballpoint pen.



### **3. Power LED**

Lights to indicate that the ACS-1216A is powered up and ready to operate.

### **4. Station ID LED**

The ACS-1216A's Station ID is displayed here. If this is a Single Station installation (see p. 2-1), or the First Station on a Daisy Chained installation (see p. 2-2), the ACS-1216A has a Station ID of **01**.

On a Daisy Chained installation, the ACS-1216A auto-senses its position and displays the Station ID that corresponds to its place in the chain. (see *Port ID Numbering*, p. 2-6 for details).

## ACS-1208A / ACS-1216A Rear View

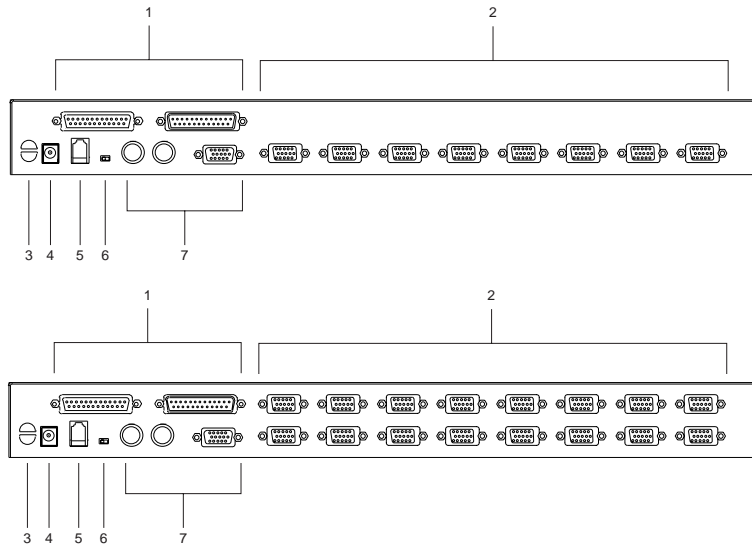

### 1. Daisy Chain Ports

When Daisy Chaining Units, the cables plug in here. The port on the left is the *Chain In* port; the one on the right is the *Chain Out* port.

### 2. CPU Port Section

The cables that link to the computers plug in here. The shape of these connectors has been specifically modified so that only cables designed to work with this switch can plug in (see the *Cables* section on p. 1-5 for details).

### 3. Cable Tie Slot

If you want to use a cable tie to gather the cables together, you can run it through this slot to attach it to the unit.

### 4. Power Jack

The power adapter cable plugs in here.

**5. Firmware Upgrade Port**

The *Firmware Upgrade Cable* that transfers the firmware upgrade data from the administrator's computer to the ACS-1208A / ACS-1216A (see p. 5-2), plugs into this RJ-11 socket.

**6. Firmware Upgrade Recovery Switch**

During normal operation and while performing a firmware upgrade, this switch should be in the NORMAL position. See p. 5-8 for details about the use of this switch.

**7. Console Port Section**

If this is a Single Station installation, or if this is the First Station unit of a daisy chained installation, the keyboard, monitor, and mouse plug in here.

**Notes:**

---

## Chapter 2.

# Installation

This chapter explains how to connect up your installation — from a basic single stage arrangement to a complete daisy chained configuration.

---

## Before you Begin

---



1. Make sure that power to all the devices you will be connecting up have been turned off. You must unplug the power cords of any computers that have the *Keyboard Power On* function. Otherwise, the switch will still receive power from the computers.
2. To prevent damage to your equipment, make sure that all devices on the installation are properly grounded.

---

## Single Stage Installation

---

In a Single Stage installation, there are no additional switches daisy chained down from the first unit. To set up a single stage installation do the following:

1. Plug your keyboard, mouse, and monitor into the unit's Console Ports.
2. Use KVM cable sets (as described in the *Cables* section on p. 1-5), to connect any available CPU Port to the Keyboard, Video and Mouse ports of the computer you are installing.

**Note:** Ignore the Daisy Chain Ports at this time. They are only used when daisy chaining additional Master View units. Daisy chaining is described in the next section.

3. Plug the power adapter cable into the Master View's Power Jack, then plug the power adapter into an AC power source.
4. Turn on the power to the computers.

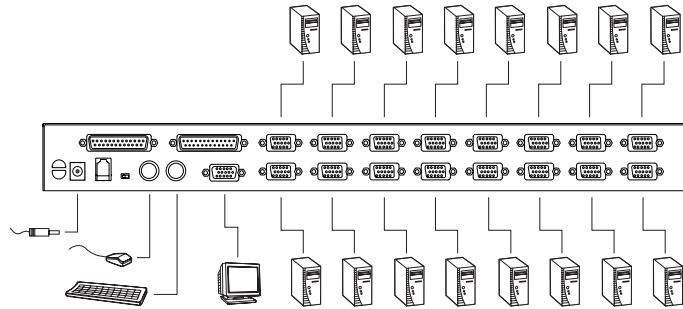

---

## Daisy Chaining

---

To control even more computers, up to 31 additional switches can be daisy chained down from the first unit. As many as 512 computers can be controlled from a single console in a complete installation. Tables showing the relation between the number of computers and the number of Master View ACS-1208A / ACS-1216A units needed to control them are provided on p. A-1 in the Appendix.

To set up a daisy chained installation, do the following:

1. Make sure that power to all the devices you will be connecting up has been turned off.

2. Use a daisy chain cable set (described in the *Cables* section, p. 1-5), to connect the *Chain Out* port of the parent switch to the *Chain In* port of the child switch (First Station Out to Second Station In, Second Station Out to Third Station In, etc.).

**Note:** You cannot use the *Chain In* port of the First Station Master View, since it is the highest level parent.

3. Use KVM cable sets (described in the *Cables* section, p. 1-5), to connect any available CPU Port on the ACS-1208A / ACS-1216A installation to the Keyboard, Video and Mouse ports of the computers you are installing.
4. Repeat the above steps for any additional ACS-1208A / ACS-1216A units you wish to add to the chain.
5. Power up the installation according to the following procedure:
  - a) Plug in the power adapter for the First Station.  
Wait for the unit to ascertain its Station ID and display it on the Station ID LED. (The Station ID for the First Stage unit is **01**, the ID for the Second Stage unit is **02**, the ID for the Third Stage unit is **03**, etc.).
  - b) Plug in the power adapters for each Station on the installation in turn (Second Station, then Third Station, etc.).  
In each case, wait for the Station ID to be ascertained and displayed on the current Station before plugging in the next one.
  - c) After all the Stations are up, power on the computers.

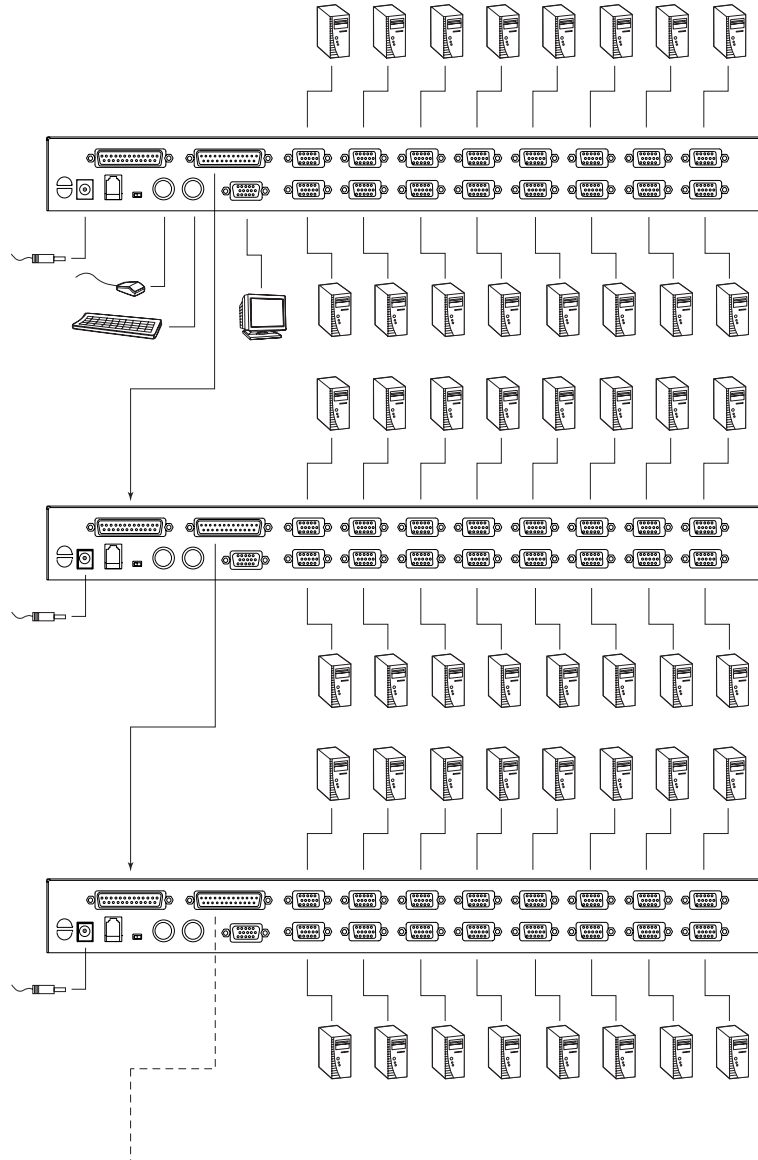



---

## Hot Plugging

---

The ACS-1208A / ACS-1216A supports *hot plugging* - components can be removed and added back into the installation by unplugging their cables from the ports without the need to shut the unit down. In order for hot plugging to work properly, however, the procedures described below must be followed:

■ **Switching Station Positions:**

You can switch station positions by simply unplugging from the old parent and plugging into a new one. After you do, in order for the OSD menus to correspond to the change, you must reset the Station IDs in the OSD. See *RESET STATION IDS*, p. 4-11, for details.

■ **Hot Plugging CPU Ports:**

In order for the OSD menus to correspond to a CPU port change, you must manually reconfigure the OSD to reflect the new port information. See *SCAN/SKIP MODE* under the *F3 SET* function (p. 4-6), and the two *Set Port* selections under the *F4 ADM* function (p. 4-8), for details.

**Note:** If the computer's Operating System does not support hot plugging, this function may not work properly.

■ **Hot Plugging Console Ports:**

The keyboard, monitor, and mouse can all be hot plugged. When hot plugging the mouse:

- a) You may unplug and replug the mouse (to reset the mouse, for example), as long as you use the *same* mouse.
- b) If you plug in a different mouse, all the stations and all the computers on the installation must be shut down for 10 seconds, then restarted following the Power Up Sequence described under Step 5 on p. 2-3.)

**Note:** If, after hot plugging there is no response to keyboard and/or mouse input, perform a *Keyboard and Mouse Reset* by pressing in the Reset button (see p. 1-8).

---

## Port ID Numbering

---

Each CPU port on a Master View installation is assigned a unique Port ID. The Port ID is made up of two parts: a two-digit *Station Number*, and a two-digit *Port Number*:

- ◆ The *Station Number* - reflects the switch's position in the daisy chain sequence. This corresponds to the number displayed on the front panel Station ID LED.
- ◆ The *Port Number* - reflects the port on the Station that the computer is connected to.
- ◆ The Station Number precedes the Port Number.
- ◆ Station and Port numbers from 1 - 9 are padded with a preceding zero, so they become 01 - 09.

For example, a computer attached to **Port 6** of **Station 12** would have a Port ID of: **12-06**.

---

## Powering Off and Restarting

---

If it becomes necessary to Power Off one of the switches, unplug its power adapter cable from the power jack. Before starting it back up you must do the following:

1. Shut down all the computers that are attached to it.

**Note:** Unplug the power cords of any computers that have the *Keyboard Power On* function. Otherwise, the switch will still receive power from the computers.

2. Wait 10 seconds, then plug the Master View back in.
3. After the ACS-1208A / ACS-1216A is up, Power On the computers.

**Note:** If you have shut down more than one Station, power up the highest Station first and work your way down to the lowest one.

## Chapter 3.

# Hotkey Operation

This chapter details the concepts and procedures involved in the Hotkey operation of your ACS-1208A / ACS-1216A installation.

---

## Hotkey Port Access

---

Hotkey port access allows you to provide KVM focus to a particular computer directly from the keyboard. The Master View ACS-1208A / ACS-1216A provides the following Hotkey port access features:

- ◆ Selecting the Active Port
- ◆ Auto Scanning
- ◆ Skip Mode Switching

---

### Invoking Hotkey Mode

All Hotkey operations begin by invoking *Hotkey Mode*. Invoking Hotkey Mode takes three steps:

1. Hold down the **Num Lock** key;
2. While the **Num Lock** key is down, press and release the **asterisk** or the **minus** key;
3. Release the **Num Lock** key:

[Num Lock] + [\*] ;

or:

[Num Lock] + [-] ;

**Note:** The asterisk or minus key must be released within one half second, otherwise Hotkey invocation is cancelled.

When Hotkey Mode is active:

- ◆ The Caps Lock and Scroll Lock LEDs flash in succession. They stop flashing and revert to normal status when you exit Hotkey Mode.
- ◆ A Command Line appears on the monitor's screen. The command line prompt is the word *Hotkey:* and appears in yellow text on a blue background. Subsequent Hotkey information that you key in displays on this line, as well.
- ◆ Ordinary keyboard and mouse functions are suspended - only Hotkey compliant keystrokes and mouse clicks (described in the sections that follow), can be input.

Pressing **[Esc]** exits Hotkey Mode.

---

### Selecting the Active Port

Each CPU port is assigned a Port ID (see *Port ID Numbering*, p. 2-6). You can directly access any computer on the installation with a Hotkey that specifies the Port ID of the CPU Port that it is connected to. The steps involved are:

1. Invoke Hotkey Mode (see p. 3-1).
2. Key in the Port ID

The Port ID numbers display on the Command Line as you key them in. If you make a mistake, use **[Backspace]** to erase the wrong number.

3. Press **[Enter]**

The KVM focus switches to the designated computer and you automatically exit Hotkey Mode.

---

## Auto Scanning

Auto Scan automatically switches among all accessible CPU Ports at regular intervals, so that the operator can monitor their activity without having to switch among them manually. (See *Scan/Skip Mode* of the OSD **F3 SET** function, p. 4-7 for information regarding accessible ports.)

### Setting the Scan Interval:

The amount of time Auto Scan dwells on each port is set with the *Scan Duration* setting of the OSD **F3 SET** function (see p. 4-7). This setting can be changed before activating Hotkey Auto Scanning with the following combination:

1. Invoke Hotkey Mode (see p. 3-1).

2. Key in **[T] [n]**

Where **[T]** is the letter **T**, and **[n]** is a number from 1-255 that represents the number of seconds for the dwell time.

The letter **T**, and the numbers display on the Command Line as you key them in. If you make a mistake, use **[Backspace]** to erase the wrong number.

3. Press **[Enter]**

You automatically exit Hotkey Mode, and are ready to invoke Auto Scanning.

### Invoking Auto Scan:

To start Auto Scanning, key in the following Hotkey combination:

1. Invoke Hotkey Mode (see p. 3-1).
2. Press [A].

You automatically exit Hotkey Mode, and enter Auto Scan Mode. The KVM focus switches among the accessible computers at regular intervals.

While you are in Auto Scan Mode, note the following:

- ◆ You can pause the scanning in order to keep the focus on a particular computer either by pressing **P** or with a Left Click of the mouse. During the time that Auto Scanning is paused, the Command Line displays the message: **Auto Scan: Paused.**

*Pausing* when you want to keep the focus on a particular computer is more convenient than Exiting Auto Scan Mode because when you resume scanning, you start from where you left off, instead of starting over from the very first computer on the installation.

To resume Auto Scanning, press any key or Left Click.

- ◆ While Auto Scan Mode is in effect, ordinary keyboard and mouse functions are suspended - only Auto Scan Mode compliant keystrokes and mouse clicks can be input. You must exit Auto Scan Mode in order to regain normal control of the console.
3. To exit Auto Scan Mode press [Esc] or [Spacebar]. Auto Scanning stops when you exit Auto Scan Mode.

---

## Skip Mode

Skip Mode allows you to switch between computers in order to monitor them manually. Unlike Auto Scanning, which automatically switches after a fixed interval, you can dwell on a particular port for as long or as little as you like.

To invoke Skip Mode, key in the following Hotkey combination:

1. Invoke Hotkey Mode (see p. 3-1).
2. Key in **[Arrow]**

Where [Arrow] refers to one of the Arrow keys. After you press [Arrow], you automatically exit Hotkey Mode, and enter Skip Mode where you can switch ports as follows:

- ← Skips from the current port to the first accessible port previous to it. (See *Scan/Skip Mode*, p. 4-7, for information regarding accessible ports.)
- Skips from the current port to the next accessible port.
- ↑ Skips from the current port to the last accessible port of the previous Station.
- ↓ Skips from the current port to the first accessible port of the next Station.

While you are in Skip Mode, note the following:

- ◆ You can keep on skipping by pressing the Arrow keys. You don't have to invoke Hotkey mode each time you want to skip.
- ◆ While Skip Mode is in effect, ordinary keyboard and mouse functions are suspended - only Skip Mode compliant keystrokes can be input. You must exit Skip Mode in order to regain normal control of the console.

1. To exit Skip Mode, press **[Esc]** or **[Spacebar]**.

---

## Hotkey Beeper Control

---

The Beeper (see Activate Beeper, p. 4-9) can be Hotkey toggled On and Off. To toggle the Beeper, key in the following Hotkey combination:

1. Invoke Hotkey Mode (see p. 3-1).
2. Press **[B]**

After you press **B**, the Beeper toggles On or Off. The Command Line displays *Beeper On* or *Beeper Off* for one second; then the message disappears and you automatically exit Hotkey Mode.

---

## Hotkey Summary Table

---

[Num Lock] + [*] or [Num Lock] + [-]	[Port ID] [Enter]	Switches access to the computer that corresponds to that Port ID.
	[T] [n] [Enter]	Sets the Auto Scan interval to <b>n</b> seconds - where <b>n</b> is a number from 1 - 255.
	[A]	Invokes Auto Scan Mode.  When Auto Scan Mode is in effect, [P] or Left Click pauses Auto Scanning. Pressing Any Key or another Left Click resumes Auto Scanning.
	[←]	Invokes Skip Mode and Skips from the current port to the first accessible port previous to it.
	[→]	Invokes Skip Mode and Skips from the current port to the next accessible port.
	[↑]	Invokes Skip Mode and Skips from the current port to the last accessible port of the previous Station.
	[↓]	Invokes Skip Mode and Skips from the current port to the first accessible port of the next Station.
	[B]	Toggles the Beeper On or Off.



## Chapter 4.

# OSD Operation

This chapter provides a complete description of the procedures involved in the OSD (On Screen Display) operation of your ACS-1208A / ACS-1216A installation.

---

## OSD Operation

---

---

### OSD Overview

The On Screen Display (OSD) is a menu driven method to handle computer control and switching operations. All procedures start from the OSD Main Screen. To pop up the Main Screen, tap the **[Scroll Lock]** key twice.

**Note:** You can optionally change the Hotkey to the Ctrl key, in which case you would tap **[Ctrl]** twice (see *OSD HOTKEY*, p. 4-6). With this method, the [Ctrl] keys must be on the same side (both left, or both right).

The OSD incorporates a two level (Administrator / User) password system. Before the OSD Main Screen comes up, a dialog box appears that asks you to provide your password. If the password function has been set, you must provide the password in order to access the OSD Main Screen.

If this is the first time that the OSD is being run, or if the password function has not been set, simply press **[Enter]**. The OSD Main Screen comes up in Administrator Mode. In this mode, you have Administrator privileges, with access to all Administrator and User functions, and can set up operations (including password authorization for the future), as you would like.

When you invoke the OSD, a screen similar to the one below appears:

SN • PN	QV	⚙	NAME
01 • 14	◀	⚙	ATEN INTL.CO. 1
01 • 15			ATEN INTL.CO. 2
01 • 16		⚙	ATEN INTL.CO. 3
02 • 01	◀	⚙	FAX SERVER 1
02 • 02			FAX SERVER 2
02 • 03	◀	⚙	WEB SERVER 1
02 • 04			WEB SERVER 2
02 • 05	◀	⚙	MAIL SERVER 1

- Note:**
1. The diagram depicts the Administrator’s Main Screen. The User Main Screen does not show the **F4** and **F6** functions, since these are reserved for the Administrator and can’t be accessed by ordinary Users.
  2. OSD always starts in List view, with the highlight bar at the same position it was in the last time it was closed.
  3. Only the ports that have been set accessible by the Administrator for the currently logged in User are visible (see *SET ACCESSIBLE PORTS*, p. 4-10, for details).

## OSD Navigation

- ◆ To dismiss the menu, and deactivate OSD, Click the **X** at the upper right corner of the OSD Window; or press **[Esc]**.
- ◆ To Logout, Click **F8** at the top of the Main Screen, or press **[F8]**.
- ◆ To move up or down through the list one line at a time, Click the Up and Down Triangle symbols (**▲▼**) or use the Up and Down Arrow Keys. If there are more list entries than what can appear on the Main Screen, the screen will scroll.
- ◆ To move up or down through the list one screen at a time, Click the Up and Down Arrow symbols (**↑↓**), or use the [Pg Up] and [Pg Dn] keys. If there are more list entries than what can appear on the Main Screen, the screen will scroll.
- ◆ To activate a port, Double Click it, or move the Highlight Bar to it then press [Enter].
- ◆ After executing any action, you automatically go back to the menu one level above.

## OSD Main Screen Headings

Heading	Explanation
SN-PN	This column lists the Port ID numbers (Station Number - Port Number) for all the CPU ports on the installation. The simplest method to access a particular computer is move the Highlight Bar to it, then press <b>Enter</b> .
QV	If a port has been selected for Quick View scanning (see <i>SET QUICK VIEW PORTS</i> , p. 4-10), an arrowhead displays in this column to indicate so.
	The computers that are powered on and are On Line have a Sun symbol in this column to indicate so.
NAME	If a port has been given a name (see <i>EDIT PORT NAMES</i> , p. 4-9), its name appears in this column.

---

## **OSD Functions**

OSD functions are used to configure and control the OSD. For example, you can: rapidly switch to any port; scan selected ports only; limit the list you wish to view; designate a port as a Quick View Port; create or edit a port name; or make OSD setting adjustments.

To access an OSD function:

1. Either Click a Function Key field at the top of the Main Screen, or press a Function Key on the keyboard.
2. In the Submenus that appear make your choice either by Double Clicking it, or moving the Highlight Bar to it, then pressing **[Enter]**.
3. Press **[Esc]** to return to the previous menu level.

### ■ **F1 GOTO:**

GOTO allows you to switch directly to a port either by keying in the port's *Name*, or its *Port ID*.

- ◆ To use the Name method, key in **1**; key in the port's Name; then press **[Enter]**.
- ◆ To use the Port ID method, key in **2**; key in the *Port ID*; then press **[Enter]**.

**Note:** You can key in a partial Name or Port ID. In that case, the screen will show all the computers that the User has *View* rights to (see *SET ACCESSIBLE PORTS*, p. 4-10), that match the Name or Port ID pattern, regardless of the current List settings (see *F2 LIST*, p. 4-5, for details).

To return to the OSD Main Screen without making a choice, press **[Esc]**.

**■ F2 LIST:**

The LIST function lets you broaden or narrow the scope of which ports the OSD displays (lists) on the Main Screen.

Many of the OSD functions only operate on the computers that have been selected for listing on the Main Screen with this function. The choices and their meanings are given in the table below:

Choice	Meaning
ALL	Lists all of the ports on the installation.
QVIEW	Lists only the ports that have been selected as Quick View Ports (see <i>SET ACCESSIBLE PORTS</i> , p. 4-10).
POWERED ON	Lists only the ports whose computers are Powered On.
QVIEW + POWERED ON	Lists only the ports that have been selected as Quick View Ports (see <i>SET QUICK VIEW PORTS</i> , p. 4-10), and whose computers are Powered On.

Move the Highlight Bar to the choice you want, then press [Enter]. An icon appears before the choice to indicate that it is the currently selected one.

### ■ F3 SET:

This function allows the Administrator and each User to set up his own working environment. A separate profile for each is stored by the OSD and is activated according to the Username that is provided during Login.

To change a setting:

1. Double Click it; or move the highlight bar to it, then press **[Enter]**.
2. After you select an item, a submenu with further choices appears. To make a selection, either Double Click it; or move the Highlight Bar to it, then press **[Enter]**. An icon appears before the selected choice to indicate which one it is. The settings are explained in the following table:

Setting	Function
OSD HOTKEY	<p>Selects which Hotkey activates the OSD function:</p> <p><b>[Scroll Lock] [Scroll Lock]</b> or <b>[Ctrl] [Ctrl]</b>.</p> <p>Since the Ctrl key combination may conflict with programs running on the computers, the default is the Scroll Lock combination.</p>
PORT ID DISPLAY POSITION	<p>Allows you to position where the Port ID appears on the screen. The default is the upper right corner, but you can choose to have it appear anywhere on the screen.</p> <p>Use the Mouse or the Arrow Keys plus Pg Up, Pg Dn, Home, End, and 5 (on the numeric keypad with Num Lock off), to position the Port ID display, then Double Click or press <b>[Enter]</b> to lock the position and return to the Set submenu.</p>
PORT ID DISPLAY DURATION	<p>Determines how long a Port ID displays on the monitor after a port change has taken place. The choices are: <b>User Defined</b> - which lets you select the amount of time (from 1 - 255 sec.); and <b>Always On</b> - which displays the Port ID at all times. If you select <i>User Defined</i>, key in the number of seconds, then press <b>[Enter]</b>. The default is 3 Seconds. A setting of 0 (zero) disables this function.</p>

(Table continues on next page)

(F3 SET: continued)

Setting	Function
PORT ID DISPLAY MODE	Selects how the Port ID is displayed: the Port Number alone ( <b>PORT NUMBER</b> ); the Port Name alone ( <b>PORT NAME</b> ); or the Port Number plus the Port Name ( <b>PORT NUMBER + PORT NAME</b> ). The default is PORT NUMBER + PORT NAME).
SCAN DURATION	Determines how long the focus dwells on each port as it cycles through the selected ports in Auto Scan Mode (see <i>F7 SCAN</i> , p. 4-14). Key in a value from 1 - 255 seconds, then press <b>[Enter]</b> . Default is 5 seconds; a setting of 0 disables the Scan function.
SCAN/SKIP MODE	<p>Selects which computers will be accessed under Skip Mode (see <i>F5 SKP</i>, p. 4-12), and Auto Scan Mode (see <i>F7 SCAN</i>, p. 4-14). Choices are:</p> <p><b>ALL</b> - All the Ports which have been set Accessible (see <i>SET ACCESSIBLE PORTS</i>, p. 4-10);</p> <p><b>QUICK VIEW</b> - Only those Ports which have been set Accessible and have been selected as Quick View Ports (see <i>SET QUICK VIEW PORTS</i>, p. 4-10);</p> <p><b>POWERED ON</b> - Only those Ports which have been set Accessible and are Powered On;</p> <p><b>QUICK VIEW + POWERED ON</b> - Only those Ports which have been set Accessible and have been selected as Quick View Ports and are Powered On. The default is ALL.</p>
SCREEN BLANKER	If there is no input from the console for the amount of time set with this function, the screen is blanked. Key in a value from 1 - 30 minutes, then press <b>[Enter]</b> . A setting of 0 disables this function. The default is 0 (disabled).
HOTKEY COMMAND MODE	Enables / Disables the Hotkey Command function in case a conflict with programs running on the computers occurs.

■ **F4 ADM:**

F4 is an Administrator only function. It allows the Administrator to configure and control the overall operation of the OSD. To change a setting Double Click it; or use the Up and Down Arrow Keys to move the highlight bar to it then press **[Enter]**.

After you select an item, a submenu with further choices for you to select from appears. Double Click the choice you want, or move the Highlight Bar to it then press **[Enter]**. An icon appears before the selected choice so that you know which one it is. The settings are explained in the following table:

Setting	Function
SET USERNAME AND PASSWORD	<p>This function is used to set Usernames and Passwords for the Administrator and Users:</p> <ol style="list-style-type: none"> <li>1. One Administrator and four User passwords can be set.</li> <li>2. After you select the Administrator field or one of the User fields, a screen that allows you to key in the password appears. The password may be up to 15 characters long, and can consist of any combination of letters and numbers (A - Z, 0 - 9).</li> <li>3. For each individual, key in the Username and Password, then press <b>[Enter]</b>.</li> <li>4. To modify or delete a previous Username and/or Password, use the backspace key to erase individual letters or numbers.</li> <li>5. As a security precaution, you should fill in a Username and Password for all four Users.</li> </ol>
SET LOGOUT TIMEOUT	<p>If there is no input from a console for the amount of time set with this function, the Operator is automatically logged out. A login is necessary before the console can be used again.</p> <p>This enables other Operators to gain access to the computers when the original Operator is no longer accessing them, but has forgotten to log out. To set the timeout value, key in a number from 1 - 180 minutes, then press <b>[Enter]</b>. If the number is 0 [zero], this function is disabled. Default is 0 (disabled).</p>

(Table continues on next page)



(F4 ADM: continued)

Setting	Function
EDIT PORT NAMES	<p>To help remember which computer is attached to a particular port, every port can be given a name. This function allows the Administrator to create, modify, or delete port names. To Edit a port name:</p> <ol style="list-style-type: none"> <li>1. Click the port you want, or use the Navigation Keys to move the highlight bar to it, then press <b>[Enter]</b>.</li> <li>2. Key in the new Port Name, or modify/delete the old one. The maximum number of characters allowed for the Port Name is 12. Legal characters include: <ul style="list-style-type: none"> <li>◆ All alpha characters: <b>a - z; A - Z</b></li> <li>◆ All numeric characters: <b>0 - 9</b></li> <li>◆ <b>+ - / : .</b> and <b>Space</b></li> </ul> <p>Case does not matter; OSD displays the Port Name in all capitals no matter how they were keyed in.</p> </li> <li>3. When you have finished editing, press <b>[Enter]</b> to have the change take effect. To abort the change, press <b>[Esc]</b>.</li> </ol>
RESTORE DEFAULT VALUES	<p>This function is used to undo all changes except for the <i>Names</i> settings, and return the setup to the original factory default settings (see <i>FACTORY DEFAULT SETTINGS</i>, p. A-2). The <i>Names</i> settings that were assigned to the Ports, are saved.</p>
CLEAR THE NAME LIST	<p>This function is similar to Restore Default Values. The difference is that it also clears the <i>Names</i> settings along with undoing all changes and returning the setup to the original factory default settings.</p>
ACTIVATE BEEPER	<p>Choices are <b>Y</b> (for Yes), or <b>N</b> (for No). When activated, the beeper sounds whenever a Port is changed; when activating the Auto Scan function (see <i>F7 SCAN</i>, p. 4-14); or an invalid entry is made on an OSD menu. The default is Y (activated).</p>

(Table continues on next page)

(F4 ADM: continued)

Setting	Function
SET QUICK VIEW PORTS	<p>This function lets the Administrator select which Ports to include as Quick View ports.</p> <ul style="list-style-type: none"> <li>◆ To select/deselect a port as a Quick View Port, Double Click the port you want, or use the Navigation Keys to move the highlight bar to it, then press <b>[Enter]</b>.</li> <li>◆ When a port has been selected as a Quick View Port, an arrowhead displays in the QV column of the LIST on the Main Screen to indicate so. When a port is deselected, the arrowhead disappears.</li> <li>◆ If one of the Quick View options is chosen for the LIST view (see <i>F2 LIST</i>, p. 4-5), only a Port that has been selected here will display on the List.</li> <li>◆ If one of the Quick View options is chosen for Auto Scanning (see <i>SCAN/SKIP MODE</i>, p. 4-7), only a Port that has been selected here will be Auto Scanned.</li> </ul> <p>The default is for no ports to be selected.</p>
SET ACCESSIBLE PORTS	<p>This function allows the Administrator to define access to the computers on the installation on a Port-by-Port basis for each User.</p> <p>For each User, select the target Port; then press the [Spacebar] to cycle through the choices: <b>F</b> (Full access), <b>V</b> (View Only), or blank. Repeat until all access rights have been set, then press <b>[Enter]</b>. The default is <b>F</b> for all users on all Ports.</p> <p><b>Note:</b> A blank setting means that no access rights are granted. The Port will not show up on the User's LIST on the Main Screen.</p>

(Table continues on next page)

(F4 ADM: continued)

Setting	Function
RESET STATION IDS	<p>If you change the position of one of the Stations in the daisy chain, the OSD settings will no longer correspond to the new situation. This function directs the OSD to rescan the Station positions of the entire installation and updates the OSD so that the OSD Station information corresponds to the new physical layout.</p> <p><b>Note:</b> Only the Station Numbers get updated. Except for the Port Names, all Administrator settings (such as Set Accessible Ports, Set Quick View Ports, etc.), for all of the computers affected by the change, have to be manually redone.</p>
FIRMWARE UPGRADE	<p>In order to upgrade the ACS-1208A / ACS-1216A's firmware (see Chapter 5), you must first invoke <i>Firmware Upgrade Mode</i> with this setting.</p>

■ **F5 SKP:**

This function enables you to easily skip backward or forward - switching the console focus from the currently active computer port to the previous or next available one.

- ◆ The selection of computers to be available for Skip Mode switching is made with the *Scan/Skip Mode* setting under the **F3 SET** function (see p. 4-7).
- ◆ When you are in Skip Mode, press [ ← ] to switch to the previous computer in the List; press [ → ] to switch to the next computer in the List; press [ ↑ ] to switch to the last computer on the previous station in the List; press [ ↓ ] to switch to the first computer on the next station in the List.

**Note:** When you Skip, you only Skip to the the previous or next available computer that is in the *Scan/Skip Mode* selection (see p. 4-7).

- ◆ If a Port has been selected for *Scan/Skip Mode*, when the focus switches to that port a Left/Right Triangle symbol appears before its Port ID Display to indicate so.
- ◆ While Skip Mode is in effect, the console will not function normally. You must exit Skip Mode in order to regain control of the console.
- ◆ To exit Skip Mode, press [**Spacebar**] or [**Esc**].

**■ F6 BRC:**

F6 is an Administrator only function. When this function is in effect, commands sent from the console are broadcast to to all available computers on the installation.

This function is particularly useful for operations that need to be performed on multiple computers, such as performing a system wide shutdown, installing or upgrading software, etc.

BRC works in conjunction with the **F2 LIST** function. The LIST function (see p. 4-5), is used to broaden or narrow the focus of which Ports appear on the OSD Main Screen. When you Broadcast a command, it only goes to the Ports currently selected to be listed on the OSD Main Screen.

- ◆ While BRC Mode is in effect, a Speaker symbol appears before the Port ID Display of the port that currently has the KVM focus.
- ◆ While BRC Mode is in effect, the mouse will not function normally. You must exit BRC Mode in order to regain control of the mouse.
- ◆ To exit BRC Mode, invoke the OSD (with the OSD Hotkey), then Click the **F6** field, or press **[F6]**, to turn BRC Mode off.

■ **F7 SCAN:**

The SCAN function allows you to automatically switch among the available computers at regular intervals so that you can monitor their activity without having to take the trouble of switching manually.

- ◆ The selection of computers to be included for Auto Scanning is made with the *Scan/Skip Mode* setting under the **F3 SET** function (see p. 4-7).
- ◆ The amount of time that each Port displays for is set with the *Scan Duration* setting under the **F3 SET** function (see p. 4-7).
- ◆ If the scanning stops on an empty port, or one where the computer is attached but is powered Off, the monitor screen will be blank, and the mouse and keyboard will have no effect. Simply wait - after the *Scan Duration* time is up, the Scan function will move on to the next port.
- ◆ As each computer is accessed, an **S** appears in front of the Port ID display to indicate that it is being accessed under *Auto Scan Mode*.
- ◆ If you want to temporarily keep the focus on a particular computer, you can pause the scanning either by pressing **P**, or with a Left Click of the mouse. See *Invoking Auto Scan*, p. 3-4, for details.
- ◆ When you want to permanently stop scanning at a particular location, press the [**Spacebar**] to stop scanning and exit Auto Scan Mode.
- ◆ To exit Auto Scan Mode, press the [**Spacebar**] or [**Esc**].

**■ F8 LOUT:**

This function logs you out of OSD control of the computers, and blanks the Console screen. After using this function you must log in all over again to regain access to the OSD.

This is different from simply pressing [Esc] when you are at the Main Screen to deactivate the OSD, where all you have to do to reenter the OSD is tap the OSD Hotkey.

- Note:**
1. When you reenter the OSD after logging out, the screen stays blank except for the OSD Main Screen. You must input your password before you can continue.
  2. If you reenter the OSD after logging out, and immediately use [Esc] to deactivate the OSD without having selected a port from the OSD menu, a Null Port message displays on the screen. The OSD Hotkey will bring up the Main OSD Screen.

**Notes:**

---



# The Firmware Upgrade Utility

This chapter explains the use and function of the Firmware Upgrade Utility: how to get the firmware upgrade files; and how to complete the process successfully.

---

## Introduction

---

---

**Purpose** The purpose of the Windows-based Firmware Upgrade Utility (FWUpgrade.exe) is to provide an automated process for making upgrading the KVM switch's firmware as smooth and painless as possible.

The Utility comes as part of a Firmware Upgrade Package that is specific for each device.

As new firmware revisions become available, new firmware upgrade packages are posted on our web site:

<http://www.aten.com.tw/basic/download.html>

Check the web site regularly to find the latest packages and information relating to them.

## Before You Begin

To prepare for the firmware upgrade, do the following:

1. From a computer that is not part of your KVM installation go to our Internet support site and choose the model name that relates to your device to get a list of available Firmware Upgrade Packages.
2. Choose the Firmware Upgrade Package you want to install (usually the most recent), and download it to your computer.
3. Use the *Firmware Upgrade Cable* (provided with this unit), to connect a COM port on your computer to the *Firmware Upgrade Port* of your device.

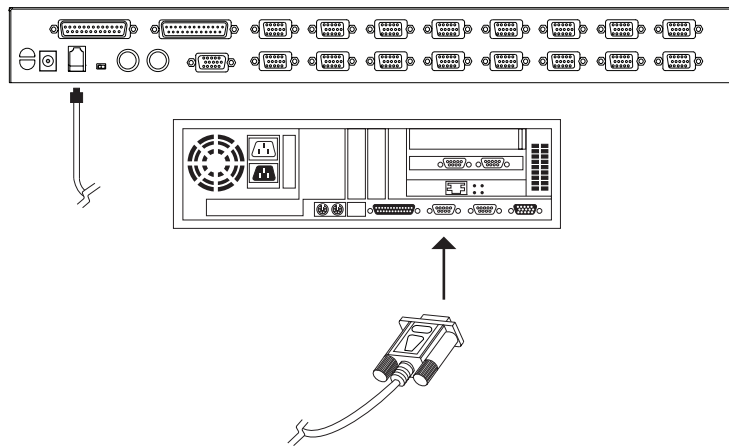

**Note:** On a daisy chained installation, connect the cable to the First Station (Master) unit. The chained stations (Slaves) will receive the upgrade via the daisy chain cables.

4. Shut down all of the computers - but not the Stations - on your KVM installation.
5. From your KVM switch console, bring up the OSD (see p. 4-1) and select the **F4ADM** function.
6. Scroll down to **FIRMWARE UPGRADE**. Press [Enter], then press [Y] to invoke Firmware Upgrade Mode (see p. 4-11.) For your reference, the current firmware upgrade version displays on the screen.

---

## Performing the Upgrade

---

### Starting the Upgrade

To upgrade your firmware:

1. Run the downloaded Firmware Upgrade Package file - either by double clicking the file icon, or by opening a command line and entering the full path to it.

The Firmware Upgrade Utility *Welcome* screen appears:



2. Read and *Agree* to the License Agreement (enable the I Agree radio button).

3. Click Next to continue. The Firmware Upgrade Utility main screen appears:

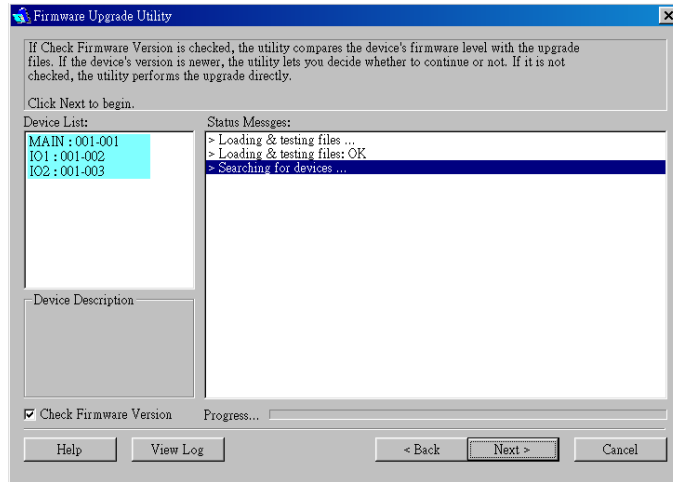

The Utility inspects your installation. All the devices capable of being upgraded by the package are listed in the *Device List* panel.

4. As you select a device in the list, its description appears in the *Device Description* panel.

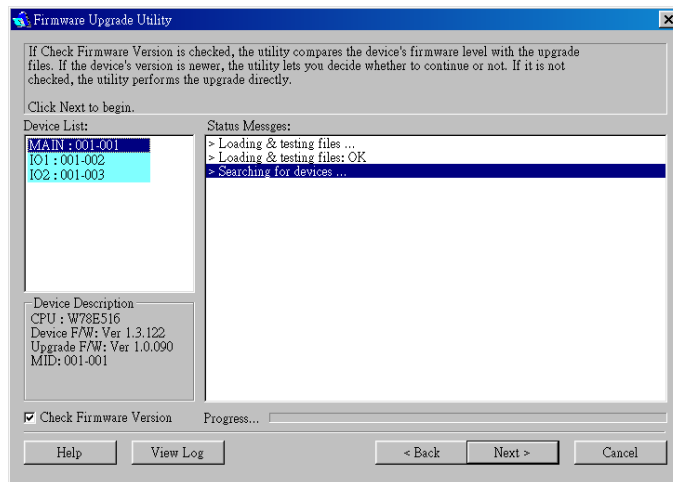

5. After you have made your device selection(s), Click **Next** to perform the upgrade.

If you enabled *Check Firmware Version*, the Utility compares the device's firmware level with that of the upgrade files. If it finds that the device's version is higher than the upgrade version, it brings up a dialog box informing you of the situation and gives you the option to Continue or Cancel.

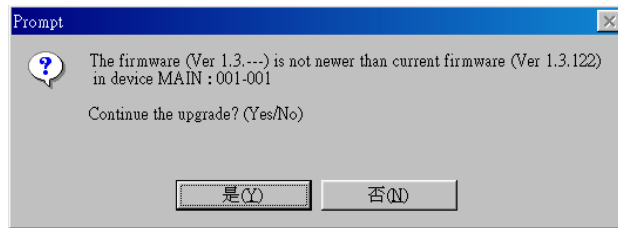

If you didn't enable *Check Firmware Version*, the Utility installs the upgrade files without checking whether they are a higher level, or not.

As the Upgrade proceeds status messages appear in the Status Messages panel, and the progress toward completion is shown on the *Progress* bar.

## Upgrade Succeeded

After the upgrade has completed, a screen appears to inform you that the procedure was successful:

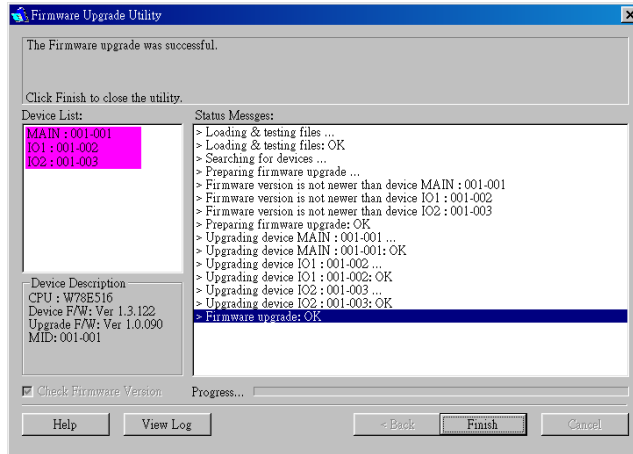

Click **Finish** to close the Firmware Upgrade Utility.

## Upgrade Failed

If the upgrade failed to complete successfully a dialog box appears asking if you want to retry. Click **Yes** to retry. If you Click **No**, the *Upgrade Failed* screen appears:

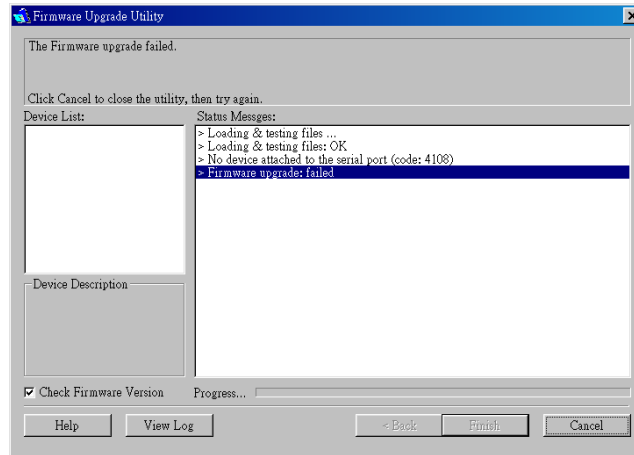

Click **Cancel** to close the Firmware Upgrade Utility. See the next section, *Firmware Upgrade Recovery*, for how to proceed.

---

## Firmware Upgrade Recovery

---

There are basically three conditions that call for firmware upgrade recovery:

- ◆ When you invoke Firmware Upgrade Mode (see p. 5-2), but decide not to proceed with the upgrade.
- ◆ When the Mainboard firmware upgrade fails.
- ◆ When the I/O firmware upgrade fails.

To perform a firmware upgrade recovery, do the following:

1. Slide the *Firmware Upgrade Recovery Switch* (see p. 1-11) to the **Recover** position.
2. Power off and restart the switch according to the instructions given in the *Powering Off and Restarting* section (p. 2-6).
3. Slide the *Firmware Upgrade Recovery Switch* back to the **Normal** position.
4. Repeat Step 2.

**Note:** If one of the slave units fails to upgrade successfully, unchain it from the installation and perform the recovery and upgrade operation independently. After it has been successfully upgraded, plug it back into the chain.



# Appendix

This appendix provides specifications and other technical information regarding the ACS-1208A / ACS-1216A.

---

## ACS-1208A /ACS-1216A - Connection Tables

---

The following tables indicate the relationship between the number of Master View units and the number of computers that they control:

---

### ACS-1208A

MVs	Computers	MVs	Computers	MVs	Computers	MVs	Computers
1	1 - 8	9	65 - 72	17	129 - 136	25	193 - 200
2	9 - 16	10	73 - 80	18	137 - 144	26	201 - 208
3	17 - 24	11	81 - 88	19	145 - 152	27	209 - 216
4	25 - 32	12	89 - 96	20	153 - 160	28	217 - 224
5	33 - 40	13	97 - 104	21	161 - 168	29	225 - 232
6	41 - 48	14	105 - 112	22	169 - 176	30	233 - 240
7	49 - 56	15	113 - 120	23	177 - 184	31	241 - 248
8	57 - 64	16	121 - 128	24	185 - 192	32	249 - 256

## ACS-1216A

MVs	Computers	MVs	Computers	MVs	Computers	MVs	Computers
1	1 - 16	9	129 - 144	17	257 - 272	25	385 - 400
2	17 - 32	10	145 - 160	18	273 - 288	26	401 - 416
3	33 - 48	11	161 - 176	19	289 - 304	27	417 - 432
4	49 - 64	12	177 - 192	20	305 - 320	28	433 - 448
5	65 - 80	13	193 - 208	21	321 - 336	29	449 - 464
6	81 - 96	14	209 - 224	22	337 - 352	30	465 - 480
7	97 - 112	15	225 - 240	23	353 - 368	31	481 - 496
8	113 - 128	16	241 - 256	24	369 - 384	32	497 - 512

## OSD Factory Default Settings

The factory default settings are as follows:

Setting	Default
OSD Hotkey	[Scroll Lock] [Scroll Lock]
Port ID Display Position	Upper Right Corner
Port ID Display Duration	3 Seconds
Port ID Display Mode	The Port Number plus the Port Name
Scan Duration	5 Seconds
Scan/Skip Mode	All
Screen Blanker	0 (Disabled)
Logout Timeout	0 (Disabled)
Beeper	Y (Activated)
Accessible Ports	F (Full) For all Users on all Ports

---

## Clear Login Information

---

If you are unable to perform an Administrator login (because the Username and Password information has become corrupted, or you have forgotten it, for example), you can clear the login information with the following procedure:

1. Power off the switch and remove its housing.
2. Short the jumper labeled *Default Password* at the right front of the switch's main board.

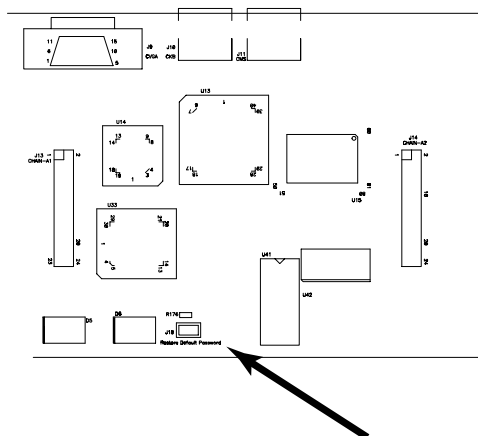

3. Power on the switch.

When you power the switch on, the following message appears on the LCD display:

```
USERNAME AND PASSWORD INFORMATION HAS BEEN CLEARED .  
PLEASE POWER OFF THE SWITCH, REMOVE THE JUMPER, CLOSE  
THE CASE, THEN RESTART .
```

4. After you start back up, the OSD login function acts exactly the way it did the first time the switch was run (see p. 4-2) and you can reset passwords for the Administrators and Users.

## Specifications

Function		ACS-1208A	ACS-1216A
Computer Connections	Direct	8	16
	Max	256 (via Daisy Chain)	512 (via Daisy Chain)
Port Selection		OSD (On Screen Display); Hotkeys	
LEDs	On Line	8 (Orange)	16 (Orange)
	Selected	8 (Green)	16 (Green)
	Power	1 (Blue)	
		2 x 7 Segments	
Console Connectors	Keyboard	1 x 6 pin mini DIN F	
	Mouse	1 x 6 pin mini DIN F	
	Video	1 x HDB-15 F	
Computer Port Connectors		8 x SPDB-15 F	16 x SPDB-15 F
Daisy Chain Ports		1 x DB-25 M; 1 x DB-25 F	
Scan Interval (OSD Select)		User Specified: 1 - 255 secs.	
Emulation	Keyboard	PS/2	
	Mouse	PS/2	
Video		1920 x 1440; DDC2B	
Power Consumption		DC 9V; 7.5W (max.)	DC 9V; 8W (max.)
Operating Temperature		0 - 50° C	
Storage Temperature		-20 - 60° C	
Humidity		0 - 80% RH	
Housing		Metal	
Weight		2.73 kg	2.83 kg
Dimensions (L x W x H)		48.3 x 15.5 x 4.5 cm (19" 1U)	

---

## Rack Mounting

---

The ACS-1208A / ACS-1216A can be mounted in a 1U system rack. For convenience and flexibility, the mounting brackets can screw into either the front or the back of the unit so that it can attach to the front or the back of the rack. To rack mount the unit do the following:

1. Screw the mounting brackets into the sides of the unit at the front or the rear, as shown in the diagrams below.
2. Slide the unit into the rack and secure it to the rack.

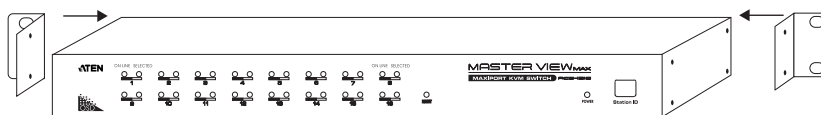
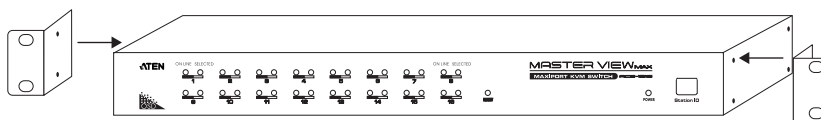

---

## Troubleshooting

---

Symptom	Possible Cause	Action
Erratic behavior.	Unit not receiving enough power.	Check that the Power Adapter that was supplied with the unit is plugged in and functioning properly.
Mouse and/or Keyboard not responding.	Improper mouse and/or keyboard reset.	Unplug the cable(s) from the console port(s), then plug it/them back in.
All Station IDs display as 01.	Station 1 has suddenly lost power.	Wait a few seconds for the system to reinitialize the station sequence and display the proper IDs.

---

## Limited Warranty

---

IN NO EVENT SHALL THE DIRECT VENDOR'S LIABILITY EXCEED THE PRICE PAID FOR THE PRODUCT FROM THE DIRECT, INDIRECT, SPECIAL, INCIDENTAL OR CONSEQUENTIAL DAMAGES RESULTING FROM THE USE OF THE PRODUCT, DISK OR ITS DOCUMENTATION.

The direct vendor makes no warranty or representation, expressed, implied, or statutory with respect to the contents or use of this documentation, and specially disclaims its quality, performance, merchantability, or fitness for any particular purpose.

The direct vendor also reserves the right to revise or update the device or documentation without obligation to notify any individual or entity of such revisions, or update. For further inquires please contact your direct vendor.

# Index

## A

ACS-1208A	
Computer Connection Table.....	A-1
Front View.....	1-6
Rear View.....	1-10
ACS-1216A	
Computer Connection Table.....	A-2
Front View.....	1-8
Rear View.....	1-10
Activate Beeper.....	4-9
ADM.....	4-8
Administrator functions.....	4-8
Auto Scanning.....	4-14
Invoking Auto Scan.....	3-4
Pausing Auto Scan.....	3-4
Scan Duration.....	4-7
Setting the Scan Interval.....	3-3
Stopping.....	3-4

## B

Beeper	
Activate.....	4-9
Control.....	3-6
BRC.....	4-13
Broadcast Mode.....	4-13

## C

Clear Login Information.....	A-3
Clear the Name List.....	4-9
Computer Connection Tables.....	A-1

## E - F

Edit Port Names.....	4-9F
F1 GOTO.....	4-4
F2 LIST.....	4-5
F3 SET.....	4-6
F4 ADM.....	4-8

F5 SKP.....	4-12
F6 BRC.....	4-13
F7 SCAN.....	4-14
F8 LOU.....	4-15
Factory Default Settings.....	A-2
Firmware upgrade.....	5-1
cable.....	5-2
port.....	1-11, 5-2
recovery.....	5-8
recovery switch.....	1-11
Firmware upgrade mode	
invoking.....	4-11

## G - H

GOTO.....	4-4
Hardware Requirements	
Computer.....	1-4
Console.....	1-4
Hardware Requirments	
Cables.....	1-5
Hot Plugging.....	2-5
Console Ports.....	2-5
CPU Ports.....	2-5
Hotkey	
Beeper Control.....	3-6
Command Mode.....	4-7
Invoking Hotkey Mode.....	3-1
OSD.....	4-6
Selecting the Active Port.....	3-2
Summary Table.....	3-6

## I

Installation	
Daisy Chaining.....	2-2
Single Stage.....	2-1
Invoke firmware upgrade.....	4-11
Invoking Hotkey Mode.....	3-1

<b>L</b>		Reset Station IDs . . . . .	4-11
LIST . . . . .	4-5	Restore Default Values . . . . .	4-9
Logout . . . . .	4-15	<b>S</b>	
Logout Timeout . . . . .	4-8	SCAN . . . . .	4-14
LOUT . . . . .	4-15	Scan Duration . . . . .	4-7
<b>O</b>		SCAN/SKIPMODE . . . . .	4-7
OSD		Screen Blanker . . . . .	4-7
Factory Default Settings. . . . .	A-2	Selecting the Active Port. . . . .	3-2
Functions . . . . .	4-4	SET . . . . .	4-6
Hotkey . . . . .	4-1, 4-6	Accessible Ports . . . . .	4-10
Logout . . . . .	4-15	Logout Timeout. . . . .	4-8
Main Screen. . . . .	4-1 - 4-2	Password . . . . .	4-8
Main Screen Headings. . . . .	4-3	Quick View Ports. . . . .	4-10
Navigation . . . . .	4-3	Username . . . . .	4-8
Overview . . . . .	4-1	Setting the Auto Scan Interval . . . . .	3-3
Password. . . . .	4-1	Skip Mode . . . . .	3-5, 4-7, 4-12
<b>P</b>		SKP. . . . .	4-12
Password . . . . .	4-1, 4-8	Specifications . . . . .	A-4
Pause . . . . .	4-14	Station IDs . . . . .	1-7, 2-3
Port ID		Reset. . . . .	4-11
Display Duration. . . . .	4-6	Station Positions	
Display Mode . . . . .	4-7	Switching. . . . .	2-5
Display Position . . . . .	4-6	Switching Station Positions. . . . .	2-5
Numbering . . . . .	2-6	<b>T</b>	
Port Names . . . . .	4-9	Timeout . . . . .	4-8
Powering Off and Restarting . . . . .	2-6	Troubleshooting . . . . .	A-6
<b>Q - R</b>		<b>U</b>	
Quick View Ports . . . . .	4-10	Upgrading the firmware. . . . .	5-1
Rack Mounting . . . . .	A-5	Username . . . . .	4-8
Recovery switch. . . . .	1-11		